



IMPORTANT pour l'installation!  
IMPORTANT for installation!  
WICHTIG für die Installation!



Scan the QR Code for the manual and video instructions  
Scannez le QR Code pour la notice et instructions vidéo  
Scannen Sie den QR-Code nach Handbuch- und Videoanweisungen



---

- un problème ? visitez [help-instore.com](http://help-instore.com)  
- a problem ? visit [help-instore.com](http://help-instore.com)  
- ein Problem ? Besuchen Sie [help-instore.com](http://help-instore.com)

## COMMUNICATION KIT FOR SHOP-IN-SHOP LIGHT

# WEBER-SIS Light 2025- Installation / Instructions / Anweisungen



## CONFIGURATION SMALL

- Configuré pour 4 à 6 barbecues (2,4 m)
- Configured for 4 to 6 barbecues (2,4 m)
- Konfiguriert für 4 bis 6 Grills (2,4 m)

## CONFIGURATION LARGE

- Configuré pour 6 à 8 barbecues (3,6 m)
- Configured for 6 to 8 barbecues (3,6 m)
- Konfiguriert für 6 bis 8 Grills (3,6 m)



Caches palette non inclus  
Pallet covers not included  
Palettenabdeckungen nicht enthalten

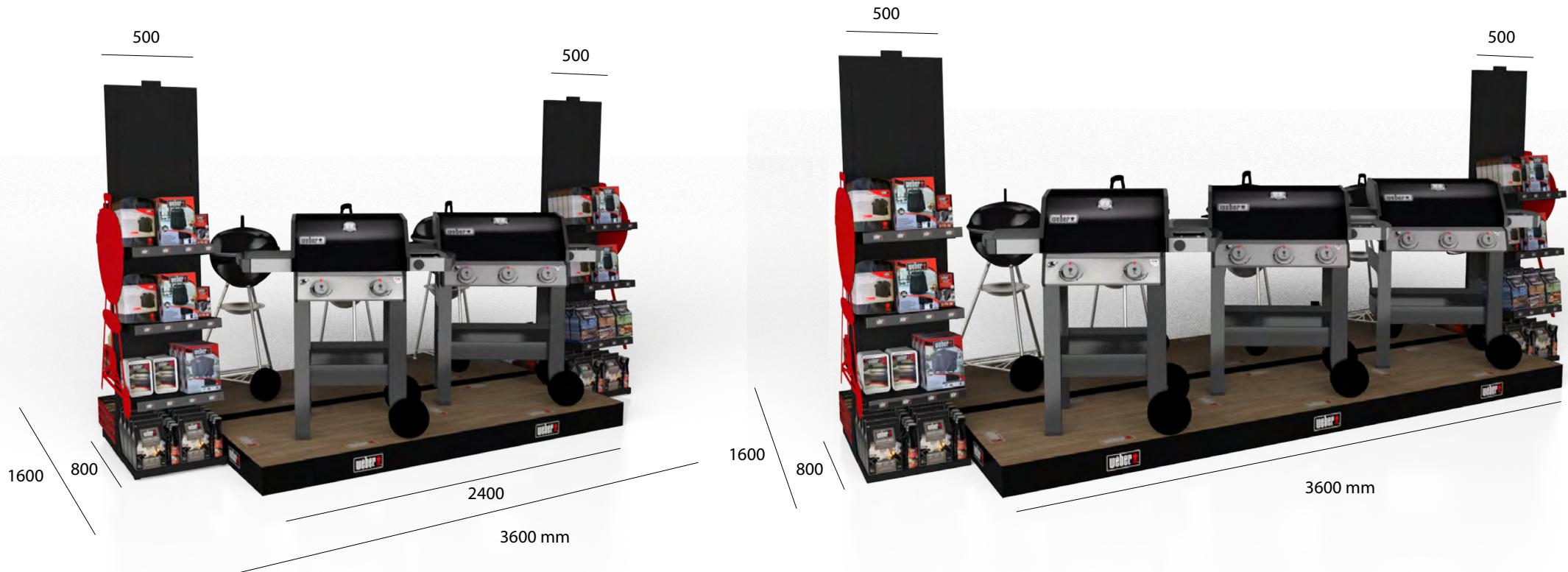

**1 KIT SIS = 2 CONFIGURATIONS**

**CE DISPOSITIF DOIT ÊTRE COMPLÉTÉ AVEC LE KIT DE COMMUNICATION LIVRÉ SÉPARÉMENT  
THIS DEVICE MUST BE COMPLETED WITH THE SEPARATELY SUPPLIED COMMUNICATION KIT.  
DIESE EINRICHTUNG MUSS MIT DEM SEPARAT GELIEFERTEN KOMMUNIKATIONSPAKET ERGÄNZT WERDEN.**

# WEBER-SIS Light 2025- Avec décors / With sets / Mit Dekorationen

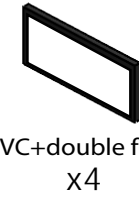
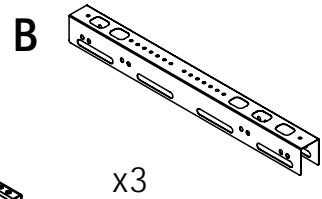
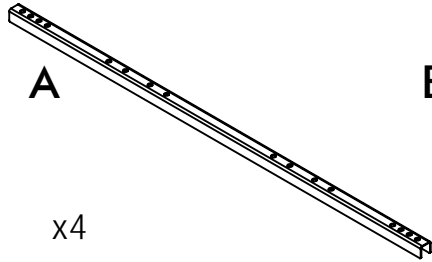

485x590mm

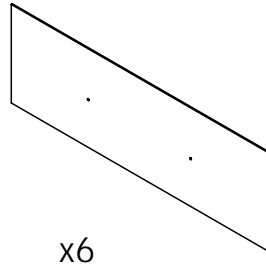
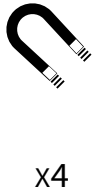

400x1200mm



x2  
x2  
x2

- Avant de commencer le montage, sortir toutes les pièces et vérifier qu'il ne manque rien.
- Before starting assembly, remove all parts and check that nothing is missing.
- Bevor du mit dem Zusammenbau beginnst, nimm alle Teile heraus und überprüfe, dass nichts fehlt.

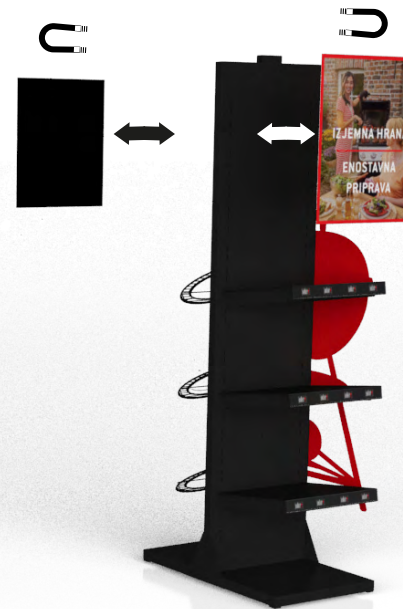
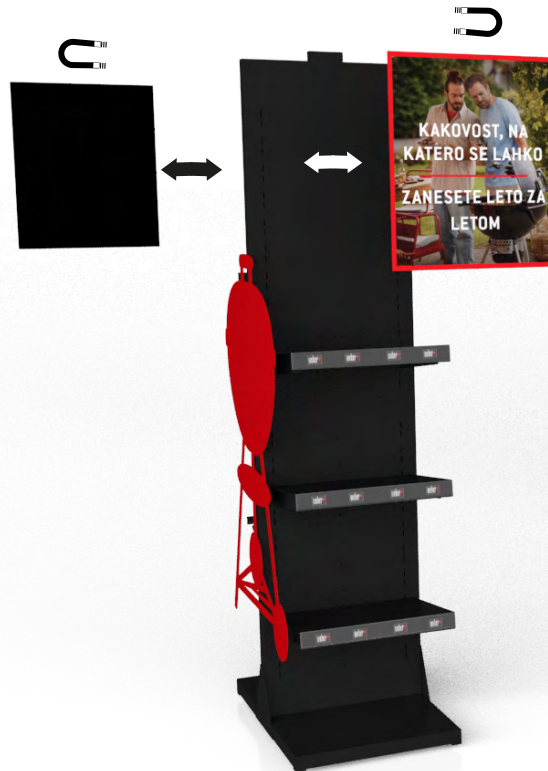

# WEBER-SIS Light 2025- Avec décors / With sets / Mit Dekorationen



Caches palette en option

Optional pallet covers

Optionale Palettenabdeckungen



Caches palette non inclus

Pallet covers not included

Palettenabdeckungen nicht enthalten



NOTE:

1600 x 2400 mm

Dedicated product Area

Total size:

1600 x 3600 mm

3600 mm

# WEBER-SIS Light 2025- Avec décors / With sets / Mit Dekorationen

## CONFIGURATION SMALL



x4

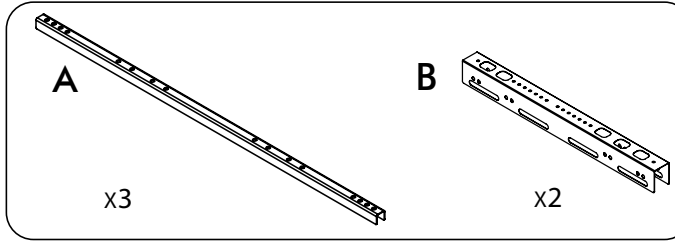
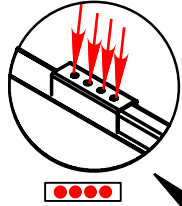

x4

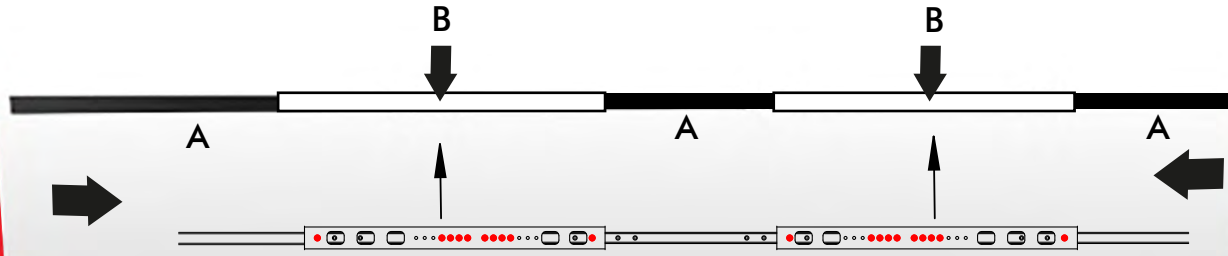
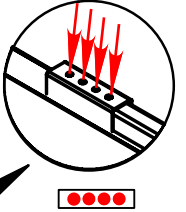

x10

x10



Clé Allen 5



- Détail de l'assemblage des traverses en page suivante
- Details of crossbar assembly on the next page
- Einzelheiten zur Montage der Querstange auf der nächsten Seite

**VIDÉO D'AIDE AU MONTAGE VIA QR CODE:  
QR CODE VIDEO TO HELP WITH ASSEMBLY:  
QR-CODE-VIDEO ALS HILFE BEI DER MONTAGE:**



# WEBER-SIS Light 2025- Avec décors / With sets / Mit Dekorationen

## CONFIGURATION SMALL

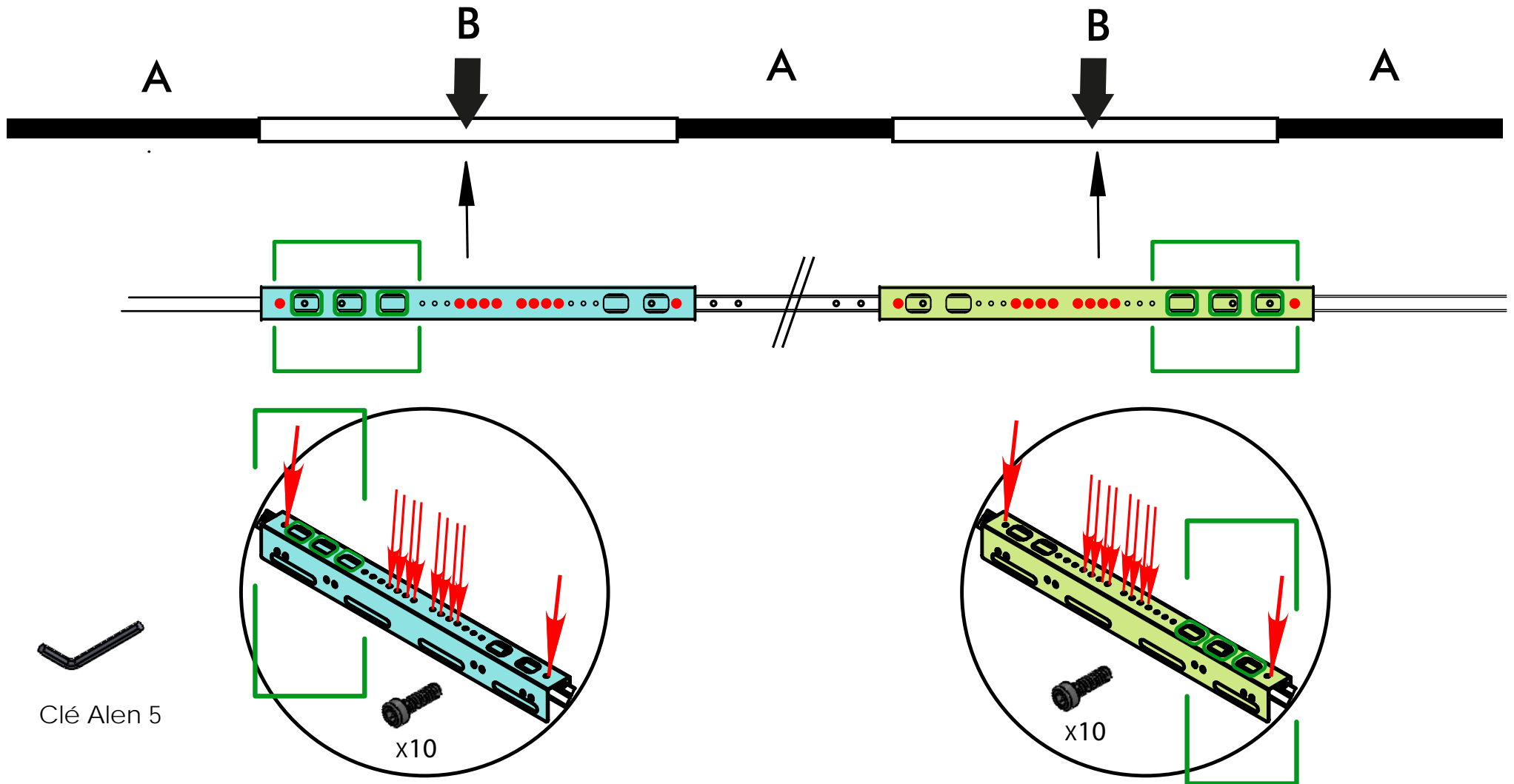

Clé Alen 5

x10

x10



- Attention au sens de montage des connecteurs B, un des 2 connecteurs est dans un sens inversé.
- Pay attention to the direction of assembly connectors B, one of the 2 connectors is in a reversed direction.
- Achten Sie auf die Montageerichtung Anschlüsse B, einer der 2 Anschlüsse ist in umgekehrter Richtung

# WEBER-SIS Light 2025- Avec décors / With sets / Mit Dekorationen

## CONFIGURATION SMALL

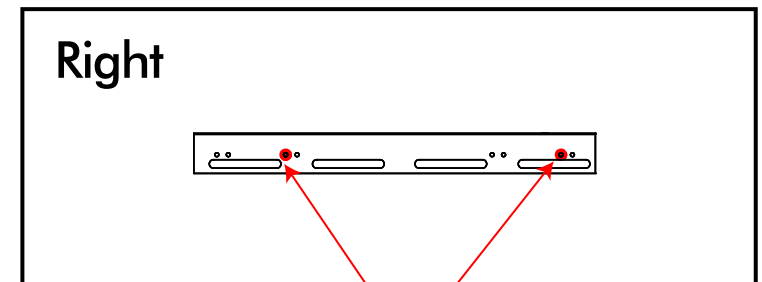
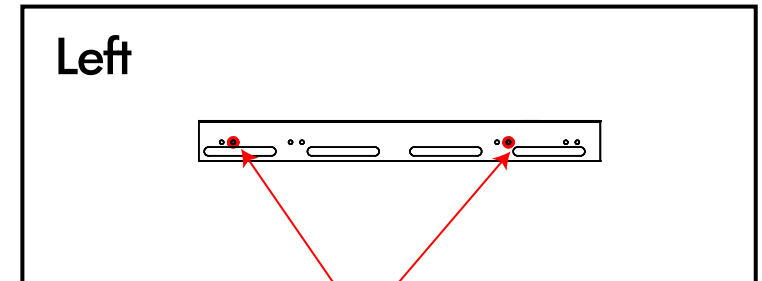
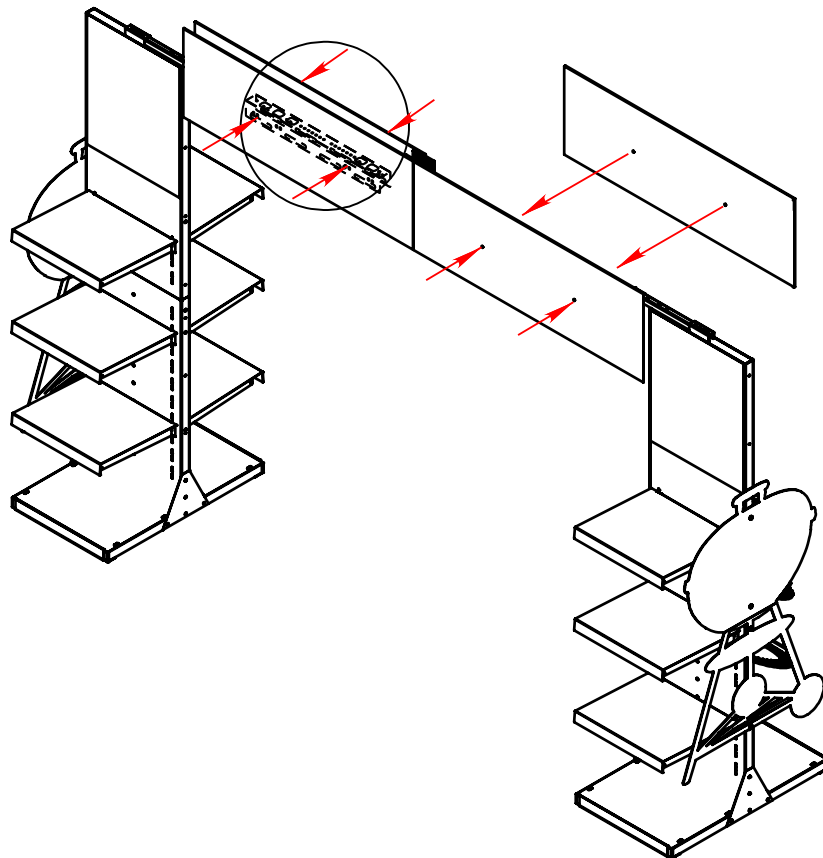
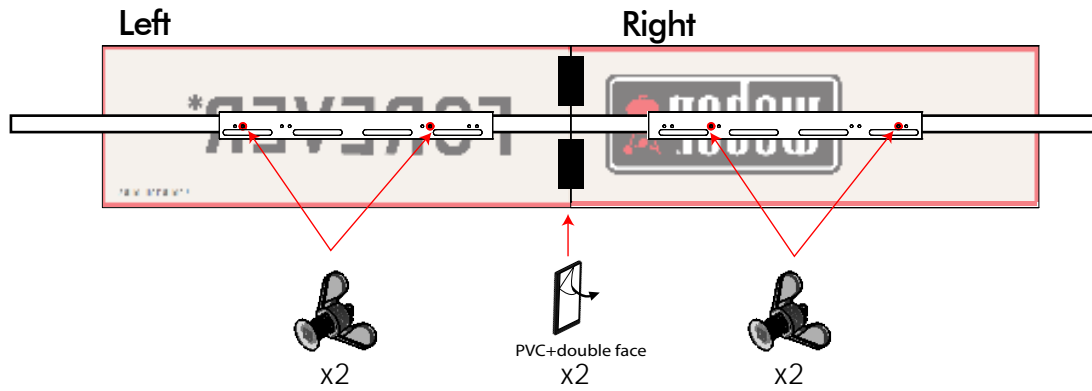

# WEBER-SIS Light 2025- Avec décors / With sets / Mit Dekorationen

## CONFIGURATION SMALL

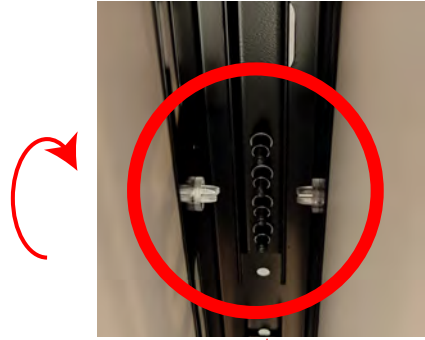
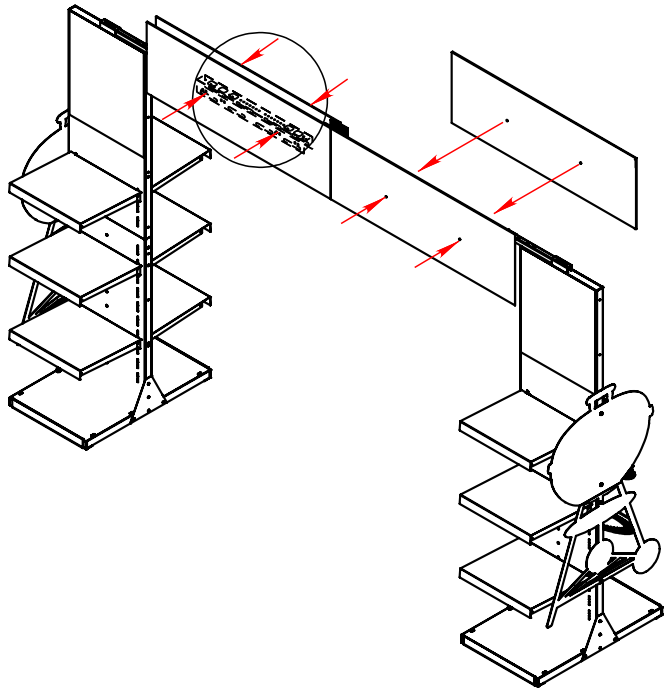

x2

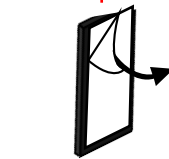
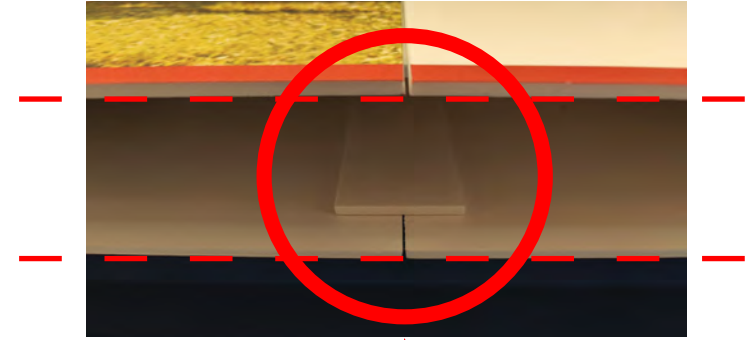

PVC+double face  
x2



- 1-Monter les vis sans complètement les serrer
- 2-Bien aligner et joindre les panneaux ensemble
- 3-Coller les plaques de PVC pour fixer les panneaux entre eux
- 4-Serrer les vis pour verrouillage

- 1-Mount screws loosely
- 2-Align and join panels together
- 3-Adhere PVC sheets to secure panels together
- 4-Tighten screws to lock

- 1-Schrauben lose montieren
- 2-Paneele ausrichten und miteinander verbinden
- 3-PVC-Folien anbringen, um die Platten miteinander zu verbinden
- 4-Schrauben zum Verriegeln anziehen



# WEBER-SIS Light 2025- Avec décors / With sets / Mit Dekorationen



Caches palette en option

Optional pallet covers

Optionale Palettenabdeckungen



Caches palette non inclus

Pallet covers not included

Palettenabdeckungen nicht enthalten



NOTE:  
1600 x 3600 mm

Dedicated product Area 500 mm

Total size:  
1600 x 4600 mm

3600 mm

500 mm

# WEBER-SIS Light 2025- Avec décors / With sets / Mit Dekorationen

## CONFIGURATION LARGE

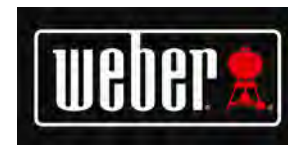

x4

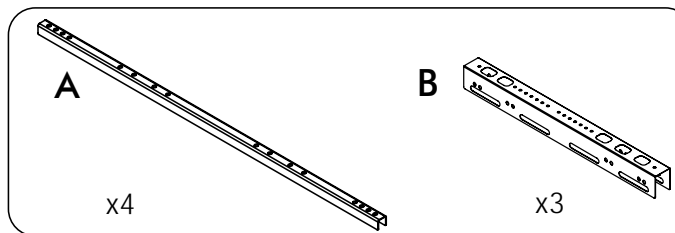
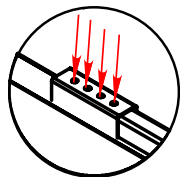

x4

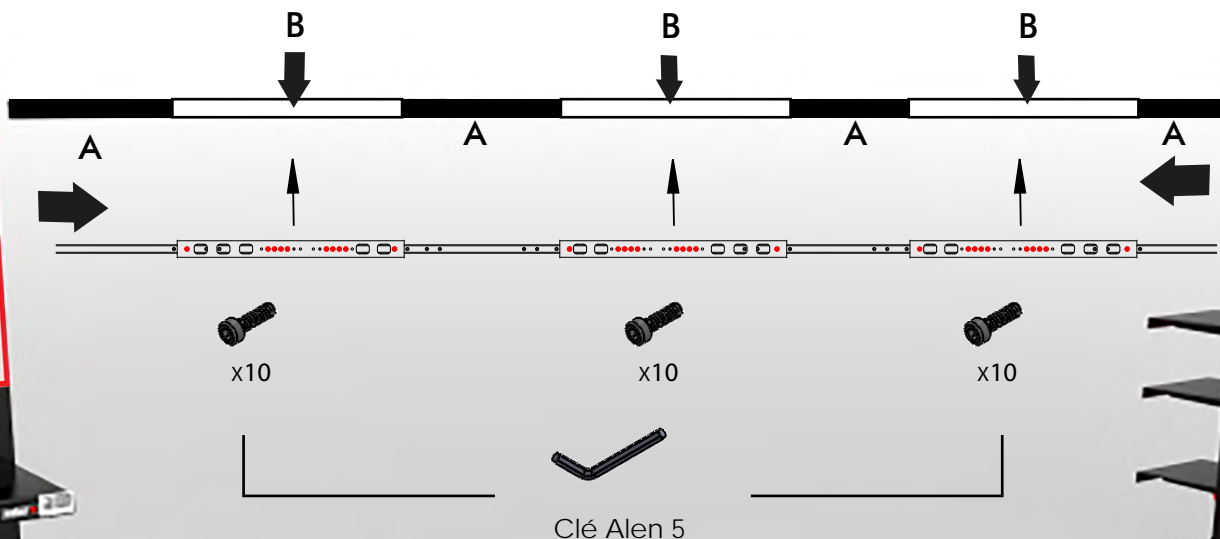
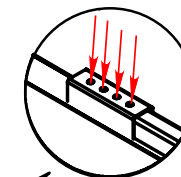

-Détail de l'assemblage des traverses en page suivante  
 -Details of crossbar assembly on the next page  
 -Einzelheiten zur Montage der Querstange auf der nächsten Seite

**VIDÉO D'AIDE AU MONTAGE VIA QR CODE:  
 QR CODE VIDEO TO HELP WITH ASSEMBLY:  
 QR-CODE-VIDEO ALS HILFE BEI DER MONTAGE:**



# WEBER-SIS Light 2025- Avec décors / With sets / Mit Dekorationen

## CONFIGURATION LARGE

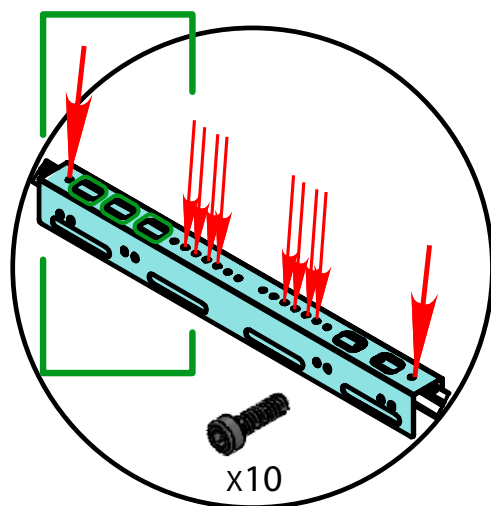
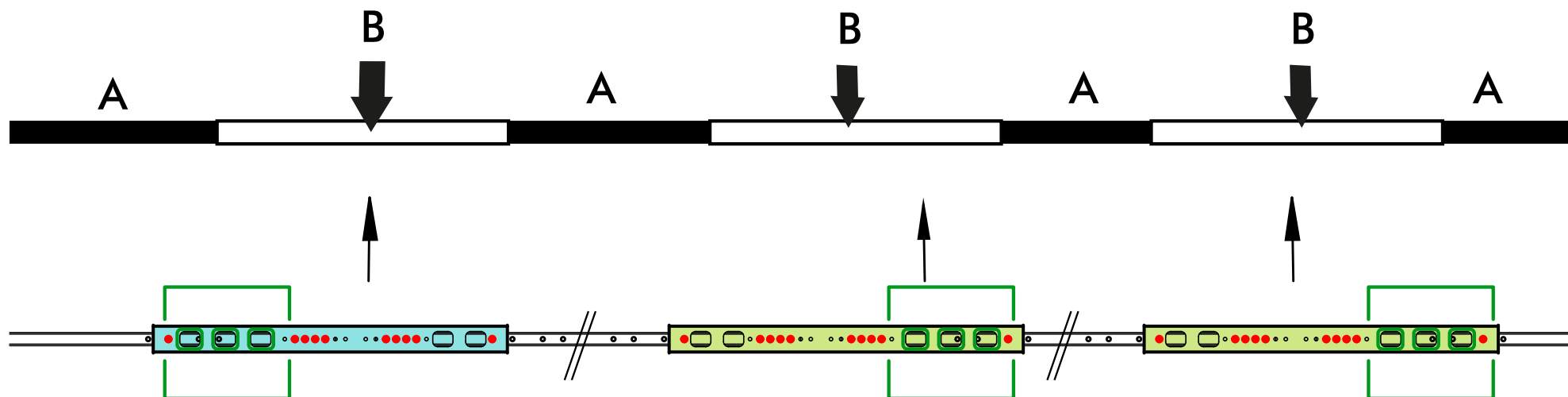
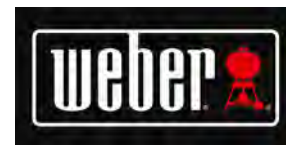

Clé Allen 5

x10

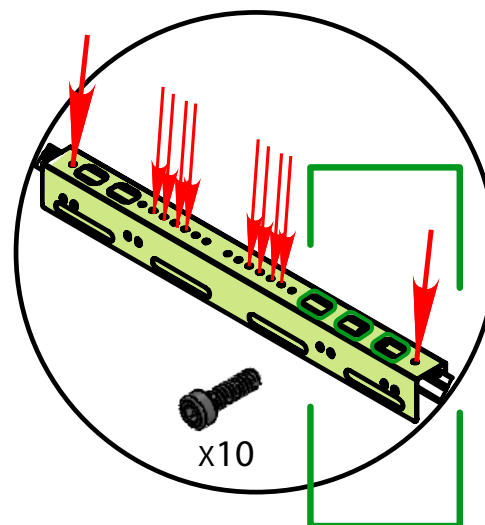

x10

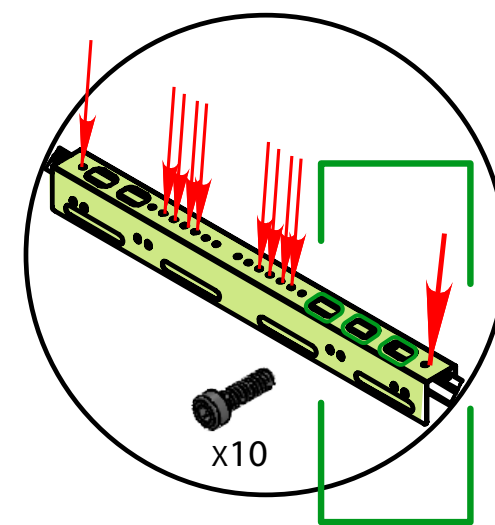

x10



- Attention au sens de montage des connecteurs B, un des 3 connecteurs est dans un sens inversé.
- Pay attention to the direction of assembly connectors B, one of the 3 connectors is in a reversed direction.
- Achten Sie auf die Montageerichtung Anschlüsse B, einer der 3 Anschlüsse ist in umgekehrter Richtung

# WEBER-SIS Light 2025- Avec décors / With sets / Mit Dekorationen

## CONFIGURATION LARGE

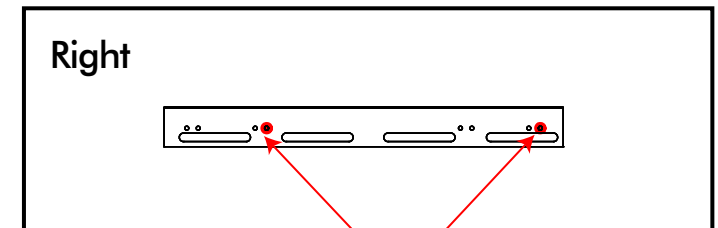
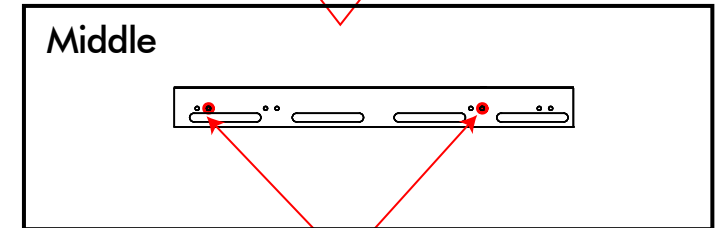
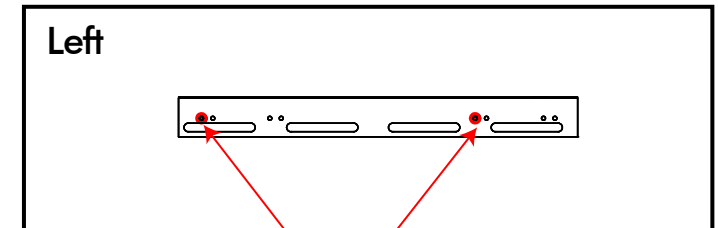
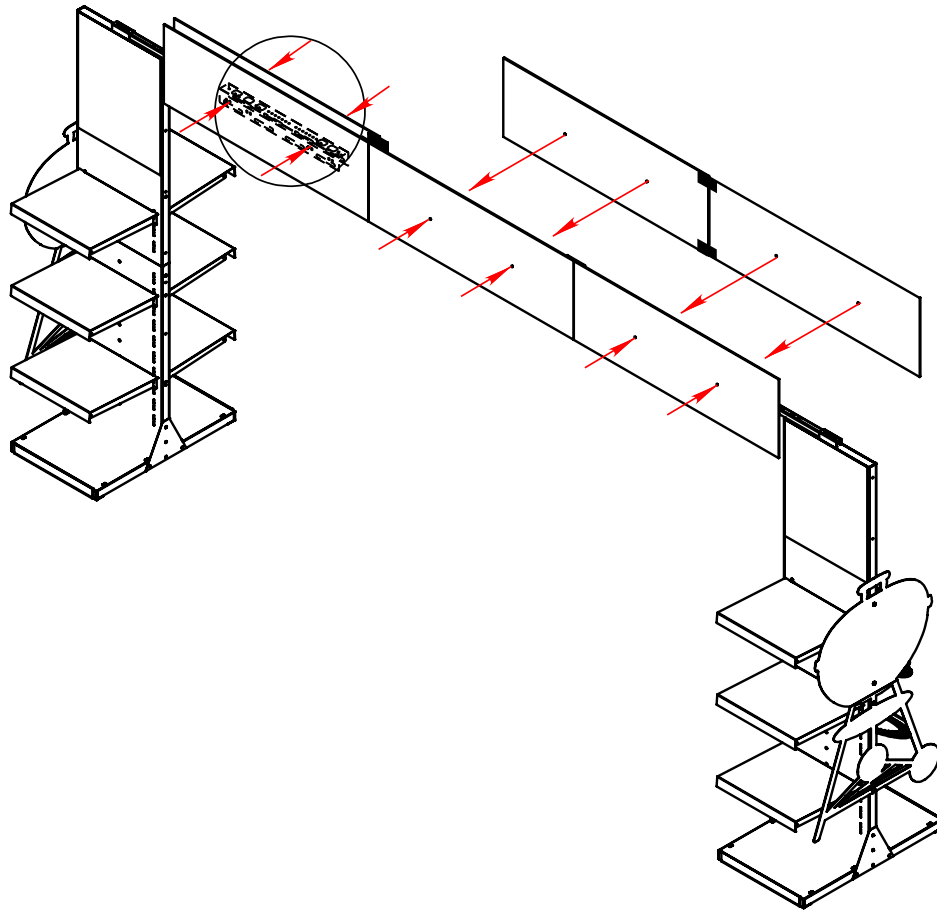
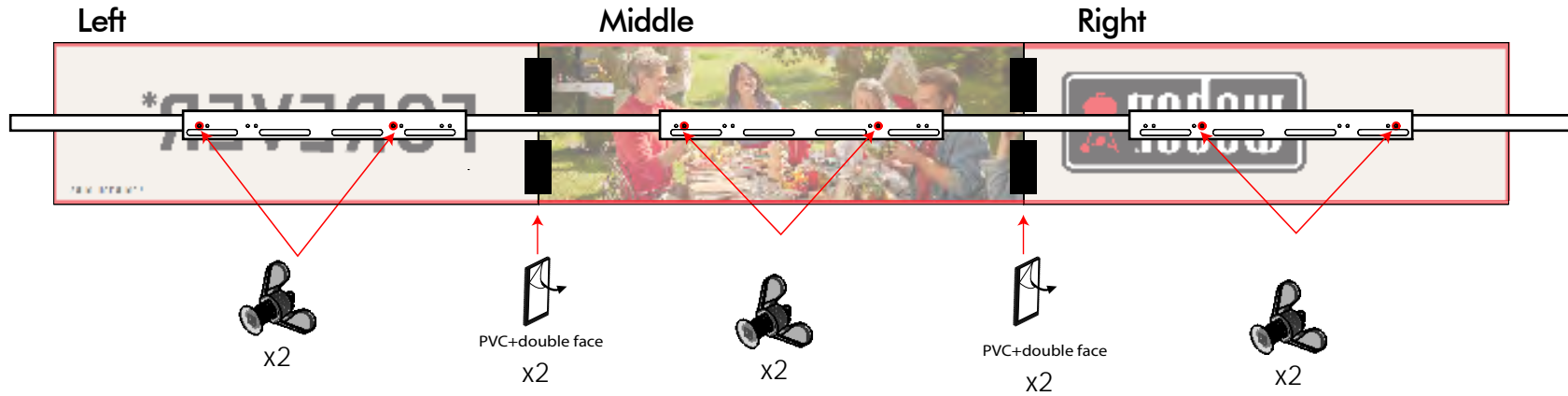

# WEBER-SIS Light 2025- Avec décors / With sets / Mit Dekorationen

## CONFIGURATION LARGE

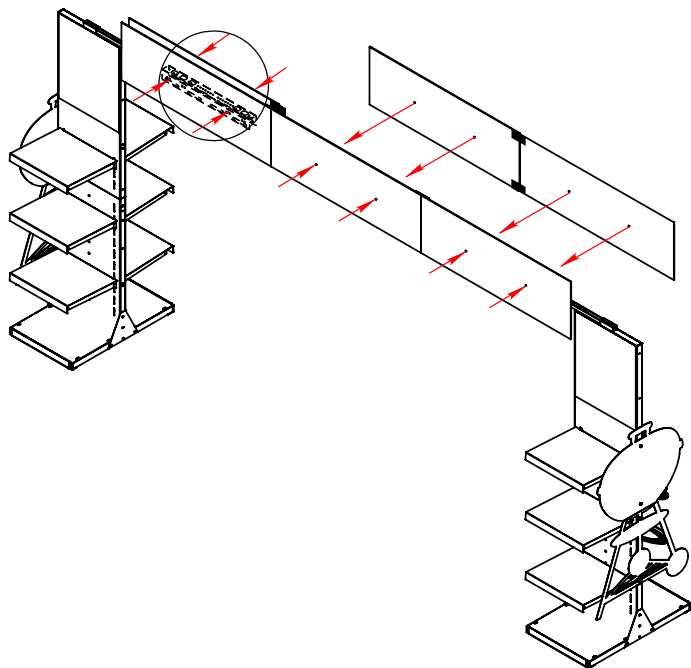
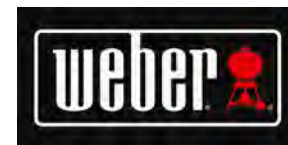

x2

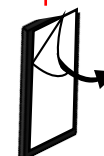

PVC+double face  
x2



- 1-Monter les vis sans complètement les serrer
- 2-Bien aligner et joindre les panneaux ensemble
- 3-Coller les plaques de PVC pour fixer les panneaux entre eux
- 4-Serrer les vis pour verrouillage

- 1-Mount screws loosely
- 2-Align and join panels together
- 3-Adhere PVC sheets to secure panels together
- 4-Tighten screws to lock

- 1-Schrauben lose montieren
- 2-Paneele ausrichten und miteinander verbinden
- 3-PVC-Folien anbringen, um die Platten miteinander zu verbinden
- 4-Schrauben zum Verriegeln anziehen

# WEBER-SIS Light 2025- Avec décors / With sets / Mit Dekorationen



## CONFIGURATION SMALL

- Configuré pour 4 à 6 barbecues (2,4 m)
- Configured for 4 to 6 barbecues (2,4 m)
- Konfiguriert für 4 bis 6 Grills (2,4 m)

## CONFIGURATION LARGE

- Configuré pour 6 à 8 barbecues (3,6 m)
- Configured for 6 to 8 barbecues (3,6 m)
- Konfiguriert für 6 bis 8 Grills (3,6 m)



**1 KIT SIS = 2 CONFIGURATIONS**

**CE DISPOSITIF DOIT ÊTRE COMPLÉTÉ AVEC LE KIT DE COMMUNICATION LIVRÉ SÉPARÉMENT  
THIS DEVICE MUST BE COMPLETED WITH THE SEPARATELY SUPPLIED COMMUNICATION KIT.  
DIESE EINRICHTUNG MUSS MIT DEM SEPARAT GELIEFERTEN KOMMUNIKATIONSPAKET ERGÄNZT WERDEN.**



## Contact:

Alain-Xavier Francois  
ax.francois@altavia-instore.com

Julien Guyonnet  
j.guyonnet@altavia-instore.com